

This drawing is the exclusive property of mbo Osswald GmbH & Co KG. Communication, reproduction and disclosure to third-parties (even if only partial) are prohibited. Any contravention will result in liability for compensation.

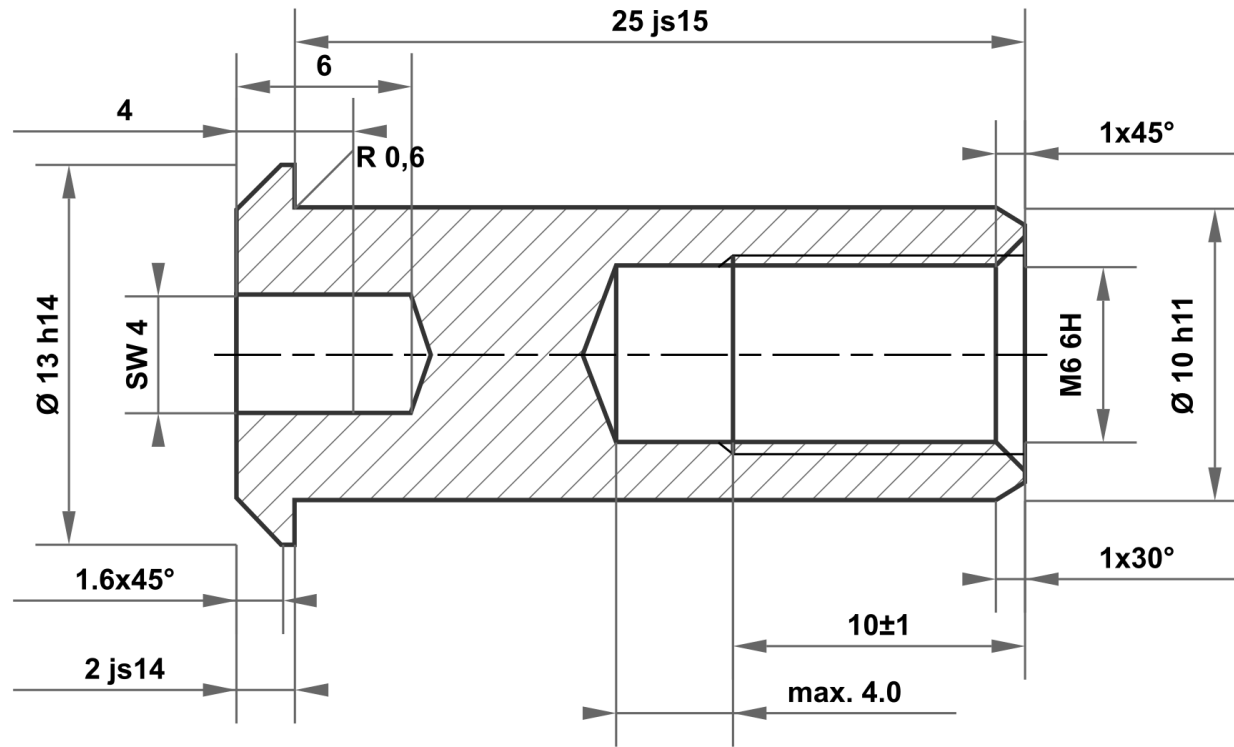

25 js15	25.420 24.580
10 h11	10.000 9.910
13 h14	13.000 12.570
2 js14	2.125 1.875

Permitted deviation for dimensions without tolerance specification ISO 2768-m for linear and angular dimensions ISO 2768-0.6 for symmetry				Surface bright		Scale		Weight	
						Material		1.4301 (X5CrNi18-10)	
				Date		Name		Identifier	
				Drawn 21.10.2025		mboShop		Sleeve nut	
				Checked					
				Standard					
								Article no	
								KT151761051849	
A				Drawing created		21.10.2025		eShop	
Status				Changes		Date		Name	
								Replacement for:	
								Replaced by:	



A4