

This drawing is the exclusive property of mbo Osswald GmbH & Co KG. Communication, reproduction and disclosure to third-parties (even if only partial) are prohibited. Any contravention will result in liability for compensation.

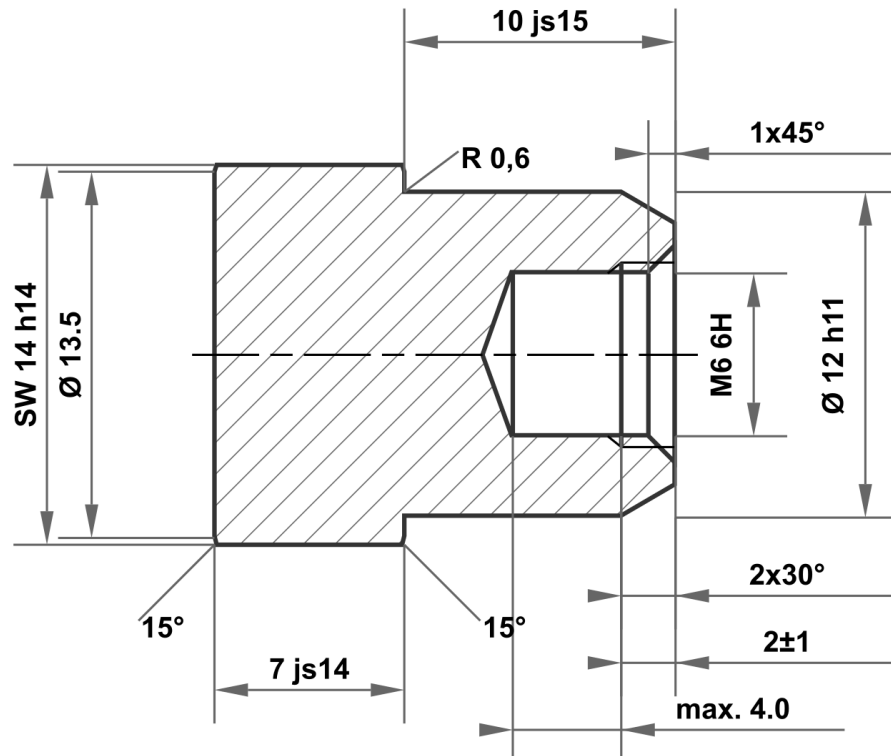

10 js15	10.290 9.710
12 h11	12.000 11.890
14 h14	14.000 13.570
7 js14	7.180 6.820

Permitted deviation for dimensions without tolerance specification ISO 2768-m for linear and angular dimensions ISO 2768-0.6 for symmetry				Surface electr. galvanised white		Scale		Weight	
						Material		1.0715 / 1.0718 according to DIN EN 10277	
				Date		Name		Identifier	
				Drawn 11.11.2025		mboShop		Sleeve nut	
				Checked					
				Standard					
								Article no	
								KT161762857345	
								A4	
A		Drawing created		11.11.2025		eShop		Replacement for:	
Status		Changes		Date		Name		Replaced by:	

