

This drawing is the exclusive property of mbo Osswald GmbH & Co KG. Communication, reproduction and disclosure to third-parties (even if only partial) are prohibited. Any contravention will result in liability for compensation.

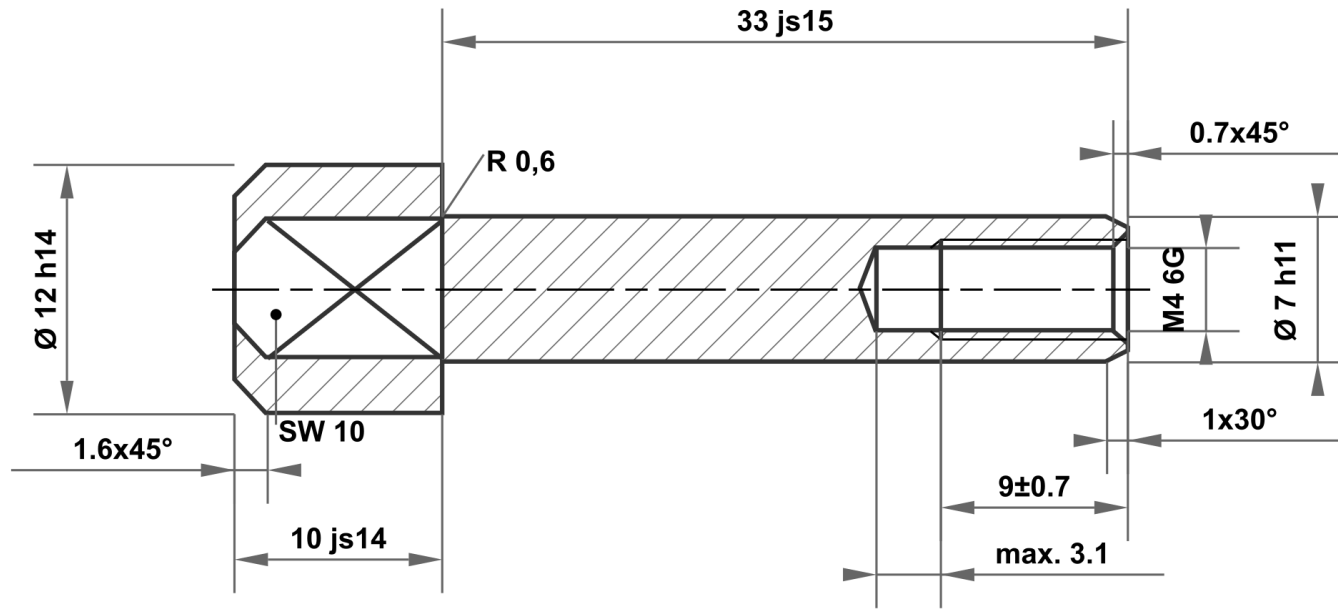

33 js15	33.500 32.500
7 h11	7.000 6.910
12 h14	12.000 11.570
10 js14	10.180 9.820

Permitted deviation for dimensions without tolerance specification ISO 2768-m for linear and angular dimensions ISO 2768-0.6 for symmetry				Surface bright, lightly oiled		Scale		Weight	
						Material		1.0715 / 1.0718 according to DIN EN 10277	
				Date		Name		Identifier	
				Drawn 08.05.2025		mboShop		Sleeve nut	
				Checked					
				Standard					
								Article no	
								KT181746735096	
								A4	
A		Drawing created		08.05.2025		eShop		Replacement for:	
Status		Changes		Date		Name		Replaced by:	

