

This drawing is the exclusive property of mbo Osswald GmbH & Co KG. Communication, reproduction and disclosure to third-parties (even if only partial) are prohibited. Any contravention will result in liability for compensation.

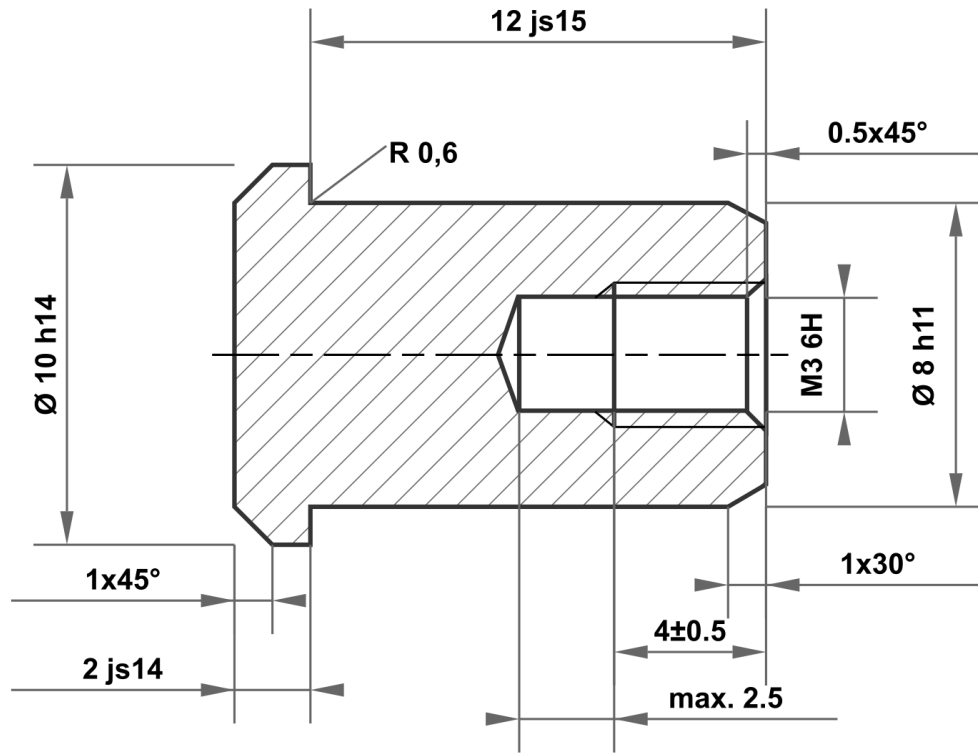

12 js15	12.350 11.650
8 h11	8.000 7.910
10 h14	10.000 9.640
2 js14	2.125 1.875

Permitted deviation for dimensions without tolerance specification ISO 2768-m for linear and angular dimensions ISO 2768-0.6 for symmetry				Surface bright		Scale		Weight	
						Material		1.4305 (X8CrNiS18-9)	
				Date		Name		Identifier	
				Drawn 18.07.2025		mboShop		Sleeve nut	
				Checked					
				Standard					
								Article no	
								KT251752814274	
								A4	
A		Drawing created		18.07.2025		eShop		Replacement for:	
Status		Changes		Date		Name		Replaced by:	

