

This drawing is the exclusive property of mbo Osswald GmbH & Co KG. Communication, reproduction and disclosure to third-parties (even if only partial) are prohibited. Any contravention will result in liability for compensation.

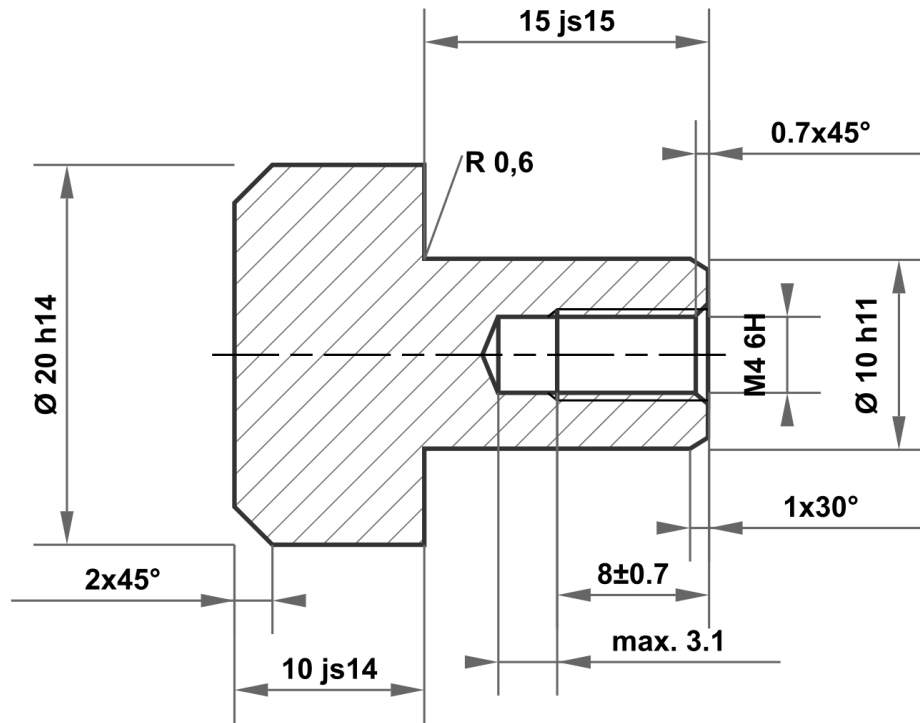

15 js15	15.350 14.650
10 h11	10.000 9.910
20 h14	20.000 19.480
10 js14	10.180 9.820

Permitted deviation for dimensions without tolerance specification ISO 2768-m for linear and angular dimensions ISO 2768-0.6 for symmetry				Surface bright		Scale		Weight	
						Material		1.4305 (X8CrNiS18-9)	
				Date		Name		Identifier	
				Drawn 14.10.2025		mboShop		Sleeve nut	
				Checked					
				Standard					
								Article no	
								KT561760436842	
								A4	
A		Drawing created		14.10.2025		eShop		Replacement for:	
Status		Changes		Date		Name		Replaced by:	

