

This drawing is the exclusive property of mbo Osswald GmbH & Co KG. Communication, reproduction and disclosure to third-parties (even if only partial) are prohibited. Any contravention will result in liability for compensation.

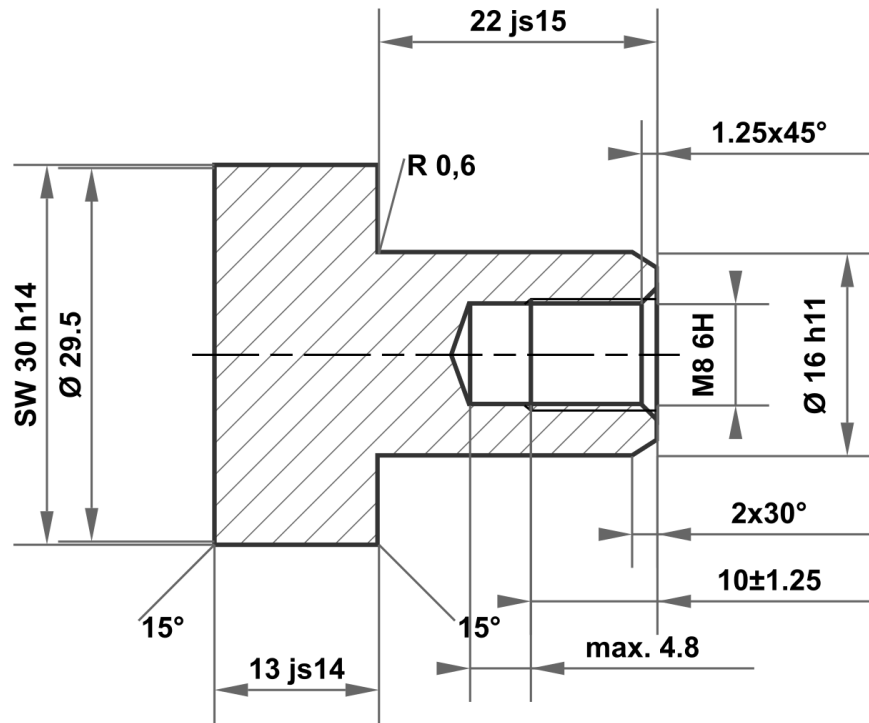

22 js15	22.420 21.580
16 h11	16.000 15.890
30 h14	30.000 29.480
13 js14	13.215 12.785

Permitted deviation for dimensions without tolerance specification ISO 2768-m for linear and angular dimensions ISO 2768-0.6 for symmetry				Surface bright		Scale		Weight	
						Material		1.4305 (X8CrNiS18-9)	
				Date		Name		Identifier	
				Drawn 24.11.2025		mboShop		Sleeve nut	
				Checked					
				Standard					
								Article no	
								KT61763977253	
								A4	
A		Drawing created		24.11.2025		eShop		Replacement for:	
Status		Changes		Date		Name		Replaced by:	

