

This drawing is the exclusive property of mbo Osswald GmbH & Co KG. Communication, reproduction and disclosure to third-parties (even if only partial) are prohibited. Any contravention will result in liability for compensation.

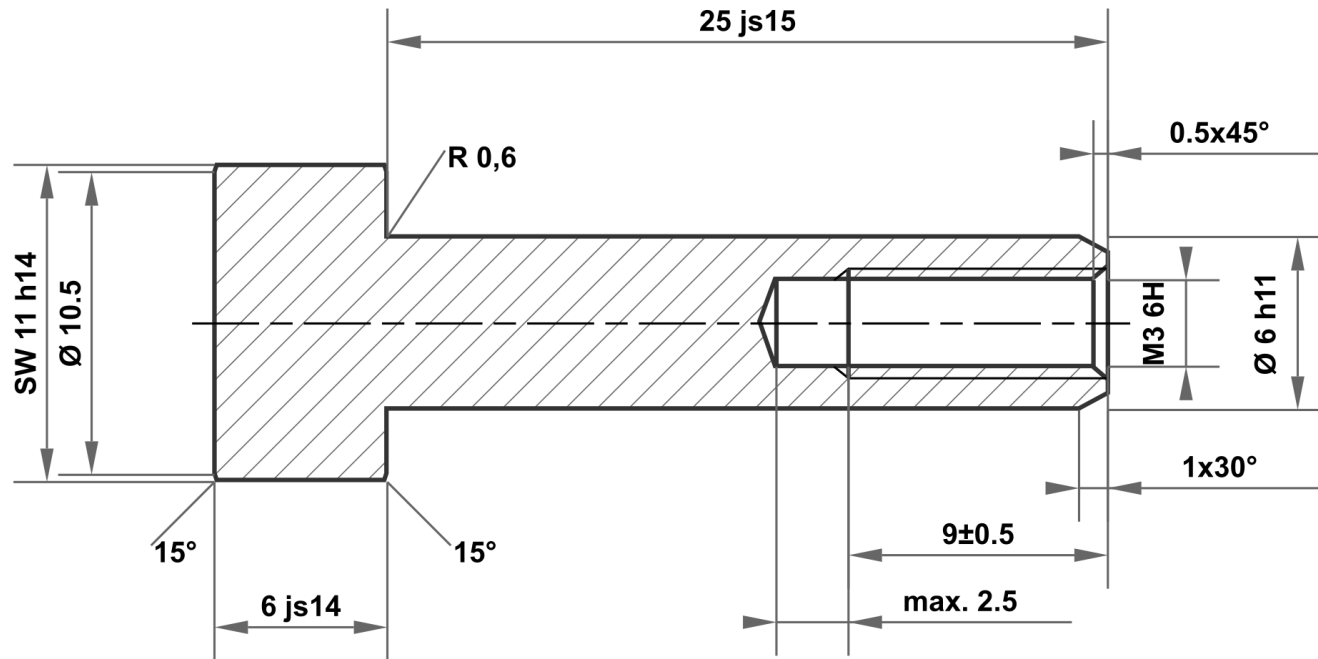

25 js15	25.420 24.580
6 h11	6.000 5.925
11 h14	11.000 10.570
6 js14	6.150 5.850

Permitted deviation for dimensions without tolerance specification ISO 2768-m for linear and angular dimensions ISO 2768-0.6 for symmetry				Surface bright		Scale		Weight	
						Material		1.4305 (X8CrNiS18-9)	
				Date		Name		Identifier	
				Drawn 20.01.2026		mboShop		Sleeve nut	
				Checked					
				Standard					
								Article no	
								KT621768913642	
								A4	
A		Drawing created		20.01.2026		eShop		Replacement for:	
Status		Changes		Date		Name		Replaced by:	

