

This drawing is the exclusive property of mbo Osswald GmbH & Co KG. Communication, reproduction and disclosure to third-parties (even if only partial) are prohibited. Any contravention will result in liability for compensation.

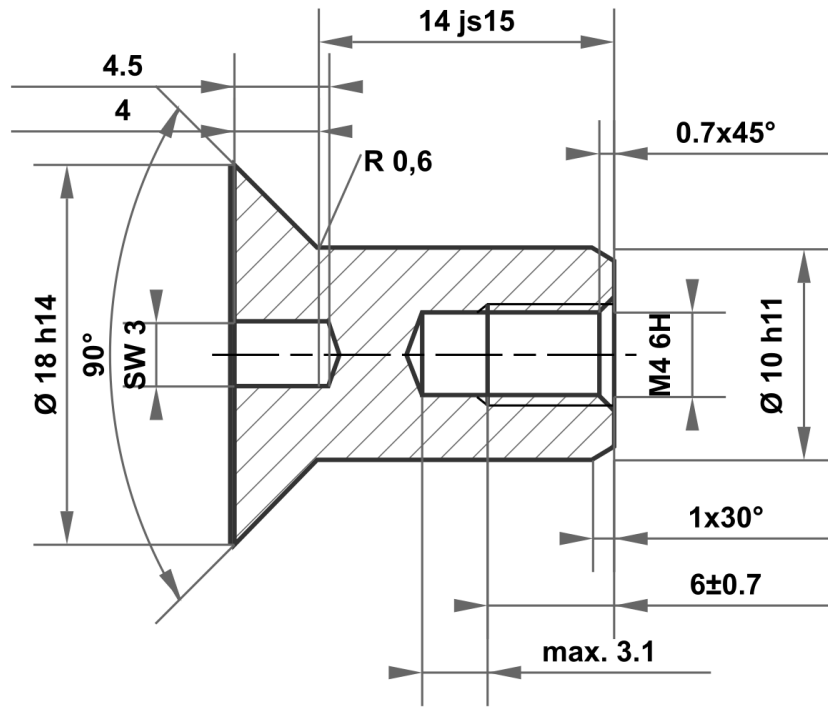

14 js15	14.350 13.650
10 h11	10.000 9.910
18 h14	18.000 17.570

Permitted deviation for dimensions without tolerance specification ISO 2768-m for linear and angular dimensions ISO 2768-0.6 for symmetry				Surface bright		Scale		Weight	
						Material		1.4305 (X8CrNiS18-9)	
				Date		Name		Identifier	
				Drawn 24.09.2025		mboShop		Sleeve nut	
				Checked					
				Standard					
								Article no	
								KT771758698149	
								A4	
A		Drawing created		24.09.2025		eShop		Replacement for:	
Status		Changes		Date		Name		Replaced by:	

