

This drawing is the exclusive property of mbo Osswald GmbH & Co KG. Communication, reproduction and disclosure to third-parties (even if only partial) are prohibited. Any contravention will result in liability for compensation.

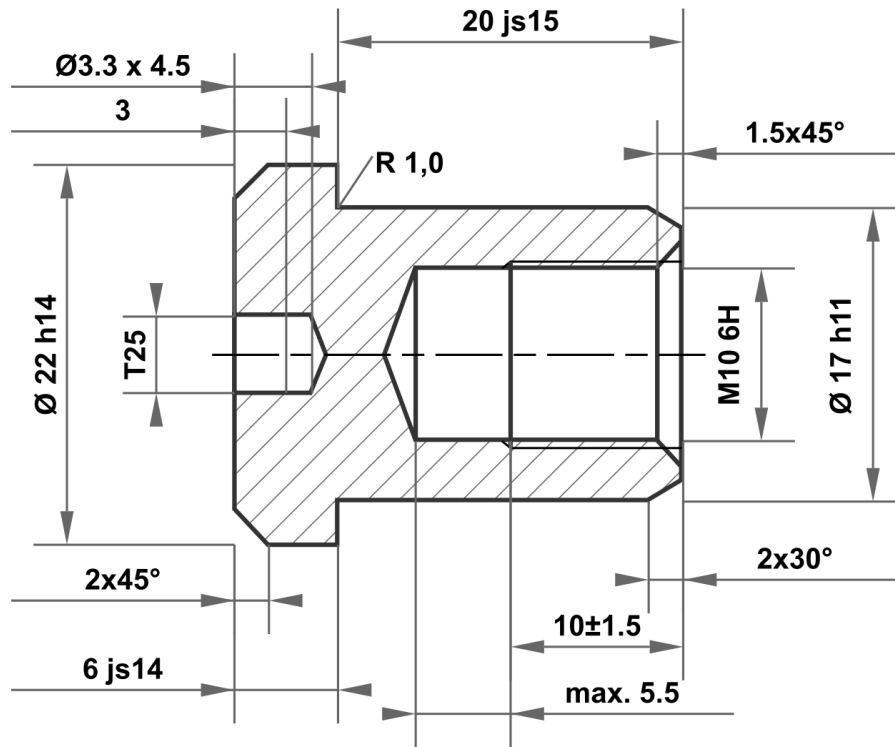

20 js15	20.420 19.580
17 h11	17.000 16.890
22 h14	22.000 21.480
6 js14	6.150 5.850

Permitted deviation for dimensions without tolerance specification ISO 2768-m for linear and angular dimensions ISO 2768-0.6 for symmetry				Surface bright		Scale		Weight	
						Material		1.4305 (X8CrNiS18-9)	
				Date		Name		Identifier	
				Drawn 30.10.2025		mboShop		Sleeve nut	
				Checked					
				Standard					
								Article no	
								KT801761831392	
								A4	
A		Drawing created		30.10.2025		eShop		Replacement for:	
Status		Changes		Date		Name		Replaced by:	

