

This drawing is the exclusive property of mbo Osswald GmbH & Co KG. Communication, reproduction and disclosure to third-parties (even if only partial) are prohibited. Any contravention will result in liability for compensation.

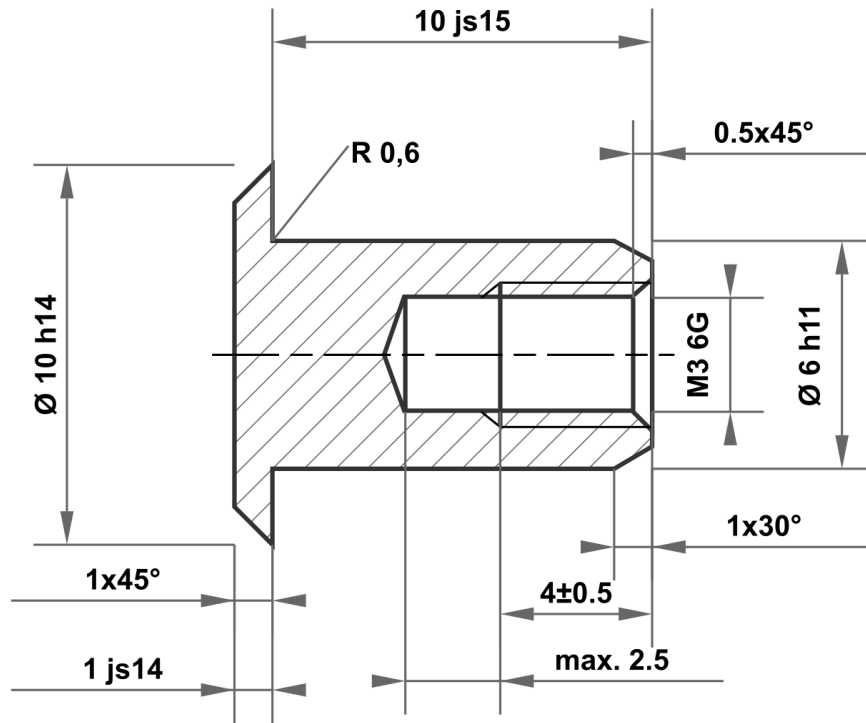

10 js15	10.290 9.710
6 h11	6.000 5.925
10 h14	10.000 9.640
1 js14	1.125 0.875

Permitted deviation for dimensions without tolerance specification ISO 2768-m for linear and angular dimensions ISO 2768-0.6 for symmetry				Surface bright, lightly oiled		Scale		Weight	
						Material		1.0715 / 1.0718 according to DIN EN 10277	
				Date		Name		Identifier	
				Drawn 24.07.2025		mboShop		Sleeve nut	
				Checked					
				Standard					
								Article no	
								KT851753359944	
								A4	
A		Drawing created		24.07.2025		eShop		Replacement for:	
Status		Changes		Date		Name		Replaced by:	

